

IR Water-Proof Network Camera

User Manual

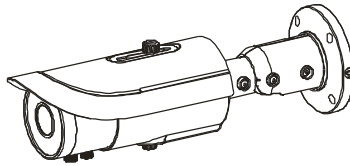

TeleEye

MP276E-HD

Please read this instruction carefully for correct use of the product

Notes

- Before operation, we strongly advise users to read this manual and keep it properly for using later.
- Please use the specified power supply to connect.
- Avoid from in correct operation, shock vibration, heavy pressing which can cause damage to product.
- Do not use corrosive detergent to clean main body of the camera. If necessary, please use soft dry cloth to wipe dirt; for hard contamination, use neutral detergent. Any cleanser for high grade furniture is applicable.
- Avoid aiming the camera directly towards extremely bright objects, such as, sun, as this may damage the image sensor.
- Please follow the instructions to install the camera. Do not reverse the camera, or the reversing image will be received.
- Do not operate it incase temperature, humidity and power supply are beyond the limited stipulations.
- Keep away from heat sources such as radiators, heat registers, stove, etc.
- This is product instructions not quality warranty. We may reserve the rights of amending the typographical errors, inconsistencies with the latest version, software upgrades and product improvements, interpretation and modification. These changes will be published in the latest version without special notification.
- When this product is in use, the relevant contents of Microsoft, Apple and Google will be involved in. The pictures and screenshots in this manual are only used to explain the usage of our product. The ownerships of trademarks, logos and other intellectual properties related to Microsoft, Apple and Google belong to the above-mentioned companies.
- This manual is suitable for IR water-proof network camera. All pictures and examples used in the manual are for reference only.

Table of Contents

1	Introduction	1
1.1	Summarization	1
1.2	Check Package Content	1
1.3	Overview	2
2	Installation.....	3
2.1	Install IP-CAM	3
2.2	Install CMS.....	4
3	IE Remote Access.....	5
3.1	LAN.....	5
3.1.1	Access through IP-Tool.....	5
3.1.2	Directly Access through IE	6
3.2	WAN.....	7
4	Remote Preview	9
4.1	The Remote Preview Interface	9
4.2	Playback	10
4.3	Snap Pictures.....	11
5	Remote Live Surveillance.....	12
5.1	System Configuration	12
5.1.1	Basic Information	12
5.1.2	Date & Time Configuration	12
5.1.3	SD Card	13
5.2	Video Configuration.....	13
5.2.1	Camera Configuration	13
5.2.2	Video Stream.....	14
5.2.3	OSD Configuration	15
5.2.4	Video Mask.....	15
5.2.5	ROI Configuration.....	16
5.3	PTZ Configuration.....	17
5.3.1	Protocol	17
5.3.2	Preset Configuration	18
5.4	Alarm Configuration.....	19
5.4.1	Motion Detection Area	19
5.4.2	Motion Detection Trigger	19
5.4.3	Motion Detection Schedule.....	20
5.4.4	Alarm Input Trigger	21
5.4.5	Alarm Input Schedule	21
5.4.6	Alarm Out	22
5.5	Network Configuration	22
5.5.1	Port	22
5.5.2	Wired.....	22
5.5.3	Server Configuration.....	23
5.5.4	IP Notify.....	23

5.5.5	DDNS Configuration	24
5.5.6	RTSP	25
5.5.7	UPnP	25
5.5.8	Mail Setting	26
5.5.9	FTP	26
5.6	Advanced Configuration	27
5.6.1	User Configuration	27
5.6.2	Security Configuration	28
5.6.3	Configure Backup & Restore	29
5.6.4	Reboot Device	30
5.6.5	Upgrade	30
6	Video Search.....	31
7	Q & A.....	33
8	Specification	35

1 Introduction

1.1 Summarization







This IP-CAMERA (short for IP-CAM) is designed for high performance CCTV solutions. It adopts state of the art video processing chips. It utilizes most advanced technologies, such as video encoding and decoding technology, complies with the TCP/IP protocol, SoC, etc to ensure this system more stable and reliable. This unit consists of two parts: the IP-CAM device and central management software (short for CMS). The CMS centralizes all devices together via internet or LAN and establishes a sound surveillance system to realize unified management and remote operation to all devices in one network.

This product is widely used in banks, telecommunication systems, electricity power departments, law systems, factories, storehouses, uptowns, etc. In addition, it is also an ideal choice for surveillance sites with middle or high risks.

Main Features

- 1080P (1920 × 1080) full real time coding
- Max. resolution: 1920 × 1080
- ICR auto switch, true day/night
- 3D DNR, digital WDR
- ROI coding
- Support CVBS output, MIC in/out, alarm in/out, RS485
- PoE power supply
- Support smart phone, iPad, remote monitoring
- Support P2P (NET Traversal)

1.2 Check Package Content

Camera	Quick Start Guide	CD	Template	Screws	DCIN&CVBS Cables	Screw-driver
						

Name	Description
Camera	The device
Quick Start Guide	Tell you how to use the camera quickly
CD	Including user manual, quick start guide, IP-Tool, CMS, etc.
Drill Template	For installation
Screws/Spiles/Screwdriver	For installation
DC IN&CVBS Cables	For testing

1.3 Overview

This series of cameras support varifocal lens and prime lens. If the camera you get is prime lens, please skip the descriptions of the zoom and focus.

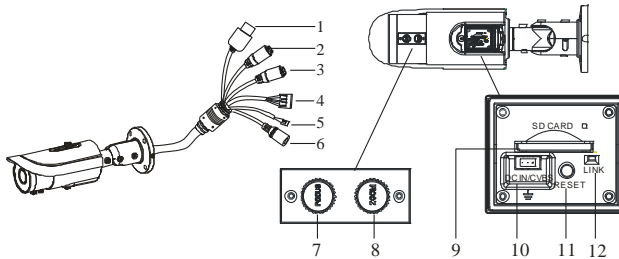

1	Network cable	7	Focus
2	MIC IN cable	8	Zoom
3	Headphone cable	9	SD card slot
4	Alarm input/output cable	10	DC IN&CVBS port for testing
5	RS485 cable	11	Reset
6	Power cable	12	Network indicator

Cable Connections

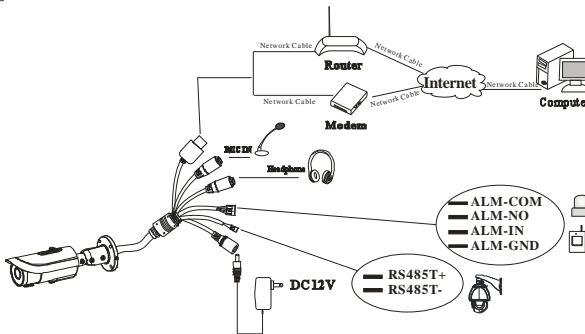

Alarm Connection:

Alarm Input: There is one independent alarm input port (ALM-IN) and one grounding port(ALM-GND). There are no type requirements for sensors. NO and NC are both available.

Join the grounding ends of the sensor and the camera and then connect the signal cable of the sensor to the alarm input port of the camera.

Alarm Output: There is 1 CH alarm output including COM and NO connections.

Loosen the screws in the alarm output port and then insert the signal wires of the alarm output devices into the port of NO and COM separately. Finally, tighten the screws. Some of the external alarm output devices need the power supply.

RS 485 Connection: You can control the speed dome by RS485 interfaces.

2 Installation

2.1 Install IP-CAM

Before you start, please make sure that the wall or ceiling is strong enough to withstand three times the weight of the camera and check whether the power supply is in conformity with your AC outlet.

The mounting steps are as follows:

- ① Attach the drill template to the place where you want to fix the camera and then drill 4 screw holes according to the drill template.

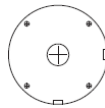

- ② Route and connect the cables.
- ③ Secure the mounting base with camera to the ceiling or wall with screws as shown below.

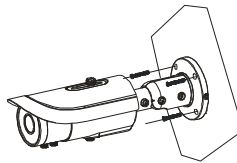

- ④ Open the case of the camera to insert SD card and then connect the monitor through the CVBS and DC IN cable.

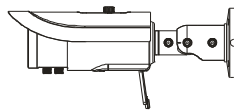

- ⑤ Three-axis adjustment. Before adjustment, preview the image of the camera on a monitor and then loosen the lock screws to adjust as shown below.

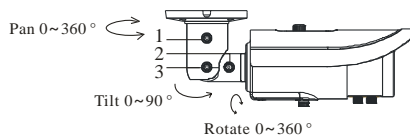

- Loosen the lock screw 1 to adjust the panning position of the camera. The adjustable range is from 0° to 360°.
- Loosen the lock screw 2 to adjust the azimuth angle of the image. The adjustable range is

from 0 ° to 360 °.

- Loosen the lock screw 3 to adjust the tilting position of the camera. The adjustable range is from 0 ° to 90 °.

After you adjusted, tighten these lock screws.

- ⑥ Focus and zoom adjustment (If the model you get doesn't support to adjust zoom and focus, please skip this step). Adjust the Focus and Zoom screws until you get the optimum image.

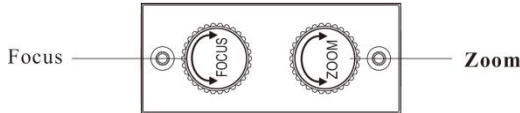

2.2 Install CMS

Find CMS software from CD and then double click "Setup.exe" file to pop up installation wizard. Install the software according to the prompts in the wizard. After you complete the installation, you will see the CMS and IP-Tool icon on the desktop. Please see the user manual of this software for more details.

If you need to install IP-Tool separately, please double click IP-Tool installation package and install it according its wizard prompts. After you finish installing, double click IP-Tool icon to start IP-Tool.

3 IE Remote Access

You may connect IP-Cam via LAN or WAN. Here only take IE browser (6.0) for example. The details are as follows:

3.1 LAN

In LAN, there are two ways to access IP-Cam: 1. Access through IP-Tool; 2. Directly access through IE browser.

3.1.1 Access through IP-Tool

- ① Make sure the PC and IP-Cam are connected to the LAN and the IP-Tool is installed in the PC from the CD.
- ② Double click the IP-Tool icon on the desktop to run this software as shown below:

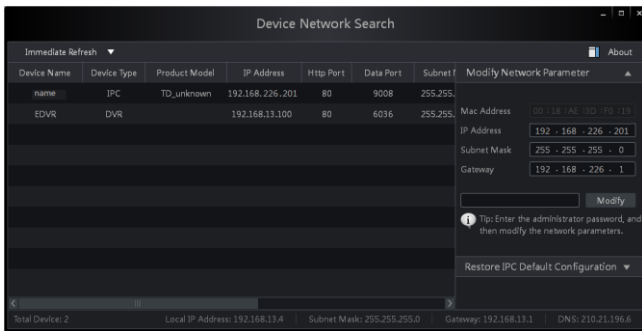

- ③ Modify the IP address. Click the information of the camera listed in the above table to show the network information on the right hand. Modify the IP address and gateway of the camera and make sure its network address is in the same local network segment as the computer's. Please modify the IP address of your device according to the practical situation.

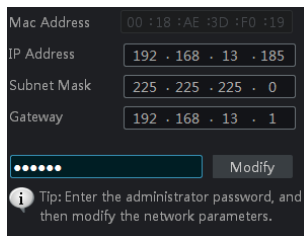

For example, the IP address of your computer is 192.168.13.4. So the IP address of the camera shall be changed to 192.168.13.X. After modification, please input the password of the administrator and click “Modify” button to modify the setting.



The default password of the administrator is “**123456**”.

④ Double click the IP address and then the system will pop up the IE browser to connect IP-CAM. IE browser will auto download the Active X control. After downloading, a login window will pop up as shown below.

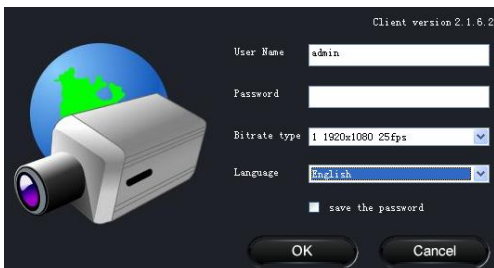

Input the username and password to log in.



The default username is “**admin**”; the default password is “**123456**”.

3.1.2 Directly Access through IE

① Manually set the IP address of the PC and the network segment should be as the same as the default settings of the IP camera. Open the network and share center. Click “Local Area Connection” to pop up the following window.

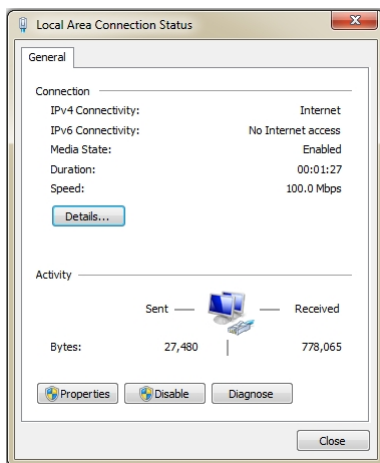

Select “Property” and then select internet protocol according to the actual situation (for example: IPV4). Next, click “Property” button to set the network of the PC.

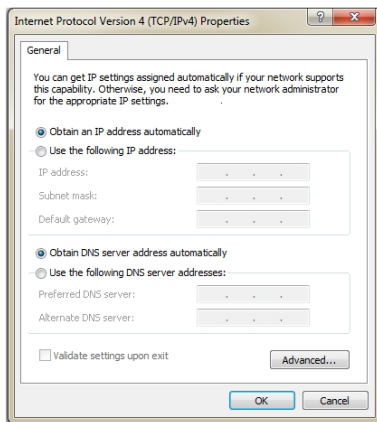

- ② Open the IE browser and input the default address of IP-CAM and confirm. The IE browser will download Active X control automatically.
- ③ After downloading Active X control, the login dialog box will pop up.
- ④ Input the default username and password and then enter to view.

3.2 WAN

Take access the camera by the router or virtual server for example

- ① Make sure the camera is well connected via LAN and then log in the camera via LAN and go to the Config→Network Config→Port menu to set up the port number.
- ② Go to Config →Network Config→Wired menu to modify the IP address.
- ③ Go to the router’s management interface through IE browser to forward the IP address and port of the camera in the “Virtual Server”.

Network basic config	
HTTP Port	<input type="text" value="80"/>
Data Port	<input type="text" value="1024"/>
RTSP Port	<input type="text" value="554"/>

Port Setup

IP Config	
<input checked="" type="radio"/> Obtain an IP address automatically	
<input type="radio"/> Use the following IP address	
IP Address	<input type="text" value="192.168.12.153"/>
Subnet Mask	<input type="text" value="255.255.255.0"/>
Gateway	<input type="text" value="192.168.12.1"/>
<input checked="" type="radio"/> Obtain DNS server address automatically	
<input type="radio"/> Use the following DNS server	
Preferred DNS server:	<input type="text" value="192.168.225.1"/>
Alternate DNS server:	<input type="text" value="8.8.8.8"/>

IP Setup

Port Range						
Application	Start	End	Protocol	IP Address		Enabl
1	9008	to 9008	Both	192.168.6.6	6	<input checked="" type="checkbox"/>
2	80	to 81	Both	192.168.6.6	6	<input checked="" type="checkbox"/>
3	10000	to 10001	Both	192.168.6.	166	<input type="checkbox"/>
4	21000	to 21001	Both	192.168.6.	156	<input type="checkbox"/>
5	7777	to 7778	Both	192.168.6.	206	<input type="checkbox"/>
6	1029	to 1030	Both	192.168.6.	207	<input type="checkbox"/>

Router Setup

- ④ Open the IE browser and input its WAN IP and http port to access.

4 Remote Preview

4.1 The Remote Preview Interface

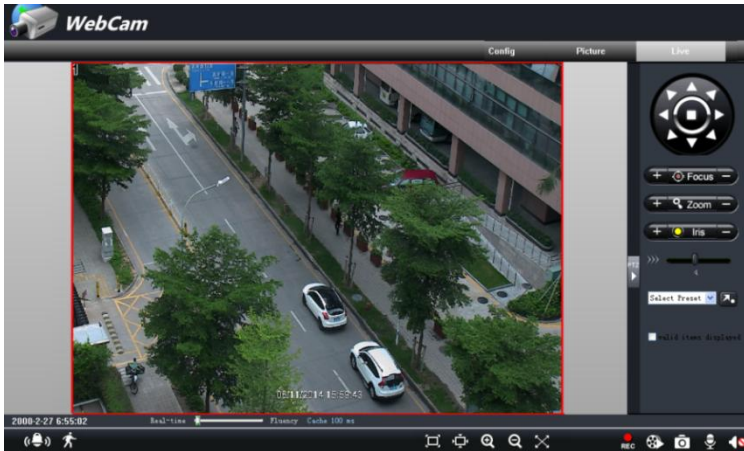

Icon	Description	Icon	Description
	Motion alarm indicator icon		Sensor alarm indicator icon
	Fix size		Start/Stop record
	Actual size		Playback
	Zoom in		Snap
	Zoom out		Talk
	Full screen		Enable audio

- When motion detection alarm is triggered, the people icon will turn red.

Right click to pop up a pull-down list as shown below:

Stream: Three streams are optional.

Turn off the live: Click this item will close present live preview.

Full screen: The live preview picture will full-screen display.

Double click or click right mouse to return to the previous interface.

Online user: Display the current user connecting to the device.

System information: Display the device information: device name, firmware version, software build date, kernel version and hardware version.



















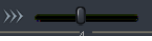

1 1080P 25fps
2 QVGA 25fps
Turn off the live

Enable audio

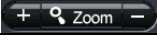

Full Screen
Online User
System Information

Click PTZ extended button to unfold PTZ control panel. In remote preview interface, you can view the image from every direction by controlling PTZ panel.

The descriptions of the control panel are as follows:

Button	Description
	 to rotate the dome upwards ;  to rotate the dome downwards;  to rotate the dome towards left;  to rotate the dome towards right ;  to rotate the dome diagonally up-left ;  to rotate the dome diagonally up-right;  to rotate the dome diagonally down-left;  to rotate the dome diagonally down-right;  to stop rotating the dome.
	Drag the scroll bar to adjust rotating speed of the dome.
	Focus button. Click  button to have long focus and click  to have short focus so that you can adjust the image clearly.
	Zoom button. Click  to zoom in the image; click  to zoom out the image.
	Iris button. Click  to increase light of the dome; click  to decrease light of the dome.

4.2 Playback

Before you play the record files, please make sure you have recorded. You make click  button to record. Then click  button to pop up a video player. Double click the record file to play the video as shown below.

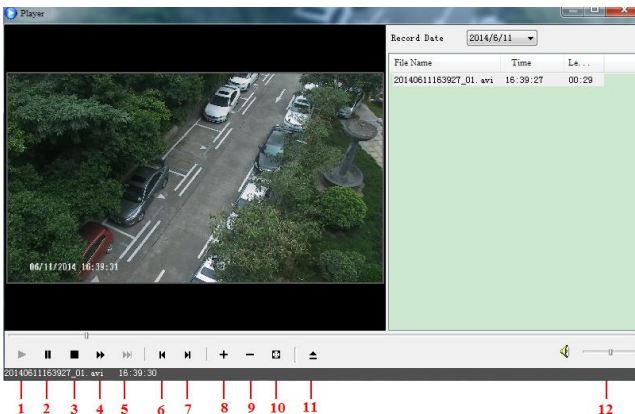

1	Play	5	Next frame	9	Zoom out
2	Pause	6	The previous file	10	Full screen
3	Stop	7	The next file	11	Path
4	Forward	8	Zoom in	12	Volume

4.3 Snap Pictures

Select the picture number, and then click “Snap”  icon as shown below:

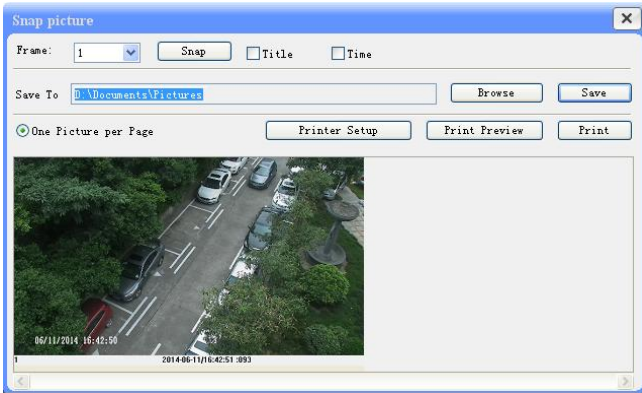

Single Snap

Snap multiple pictures

Select the picture number from Frame pull down list box, such as 2, and check “Title” and “Time” to show capture title and time on the snap pictures simultaneously.

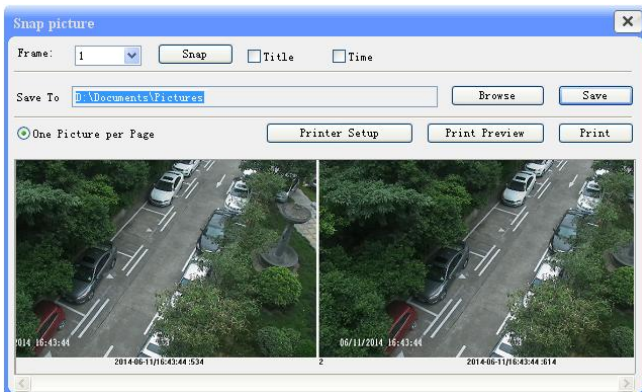

Multi-picture Snap

5 Remote Live Surveillance

Functions of remote configurations include: System Configuration, Video Configuration, PTZ Configuration, Alarm Configuration, Network Configuration and Advanced Configuration. You should firstly select the menu on the left, and then set the relative parameters. When one user configures parameters of a certain device, other users can not set this device.

5.1 System Configuration

The “System configuration” includes three submenus: Basic Information, Date & Time and SD card.

5.1.1 Basic Information

In the “Basic Information” interface, you can set up the device name and can also check the relative information of the server.

Setting steps:

1. Clicking the “Config” icon will appear the menu list.
2. Clicking the “Basic Information” will pop up a window as shown below:
3. Input the name of the device in the “Device name” text box.
4. Press the “Save” button to save the settings.

System Information			
Software Version	<input type="text" value="3.4.0 beta7"/>	Software Build Date	<input type="text" value="2014-6-3 (YYYY-MM-DD)"/>
Kernel Version	<input type="text" value="20140508"/>	Hardware Version	<input type="text" value="1.3"/>
MAC	<input type="text" value="00:18:AE:44:43:02"/>	Onvif Version	<input type="text" value="2.3"/>
Device name	<input type="text" value="name"/>	Maximum number of	<input type="text" value="4"/>

Please refer to the following table for parameters and instructions of server basic configuration.

<i>Parameter</i>	<i>Meaning</i>
Software version	The software of the device
Software build date	The software build date of the device
Kernel version	The kernel version of the device
Hardware version	The hardware version of the device
Mac Address	MAC address of device
Maximum number of user	Support max 4 users to access
Device name	Name of the device.

5.1.2 Date & Time Configuration

Setting steps:

1. Go to Config→Date & Time menu as shown below.

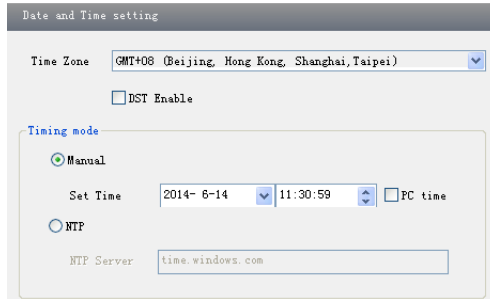

2. Set time zone.
3. Enable DST mode as required.
4. Set time. You may set time manually or enable NTP.

5.1.3 SD Card

1. Go to “System Configuration” → “SD Card” as shown below:

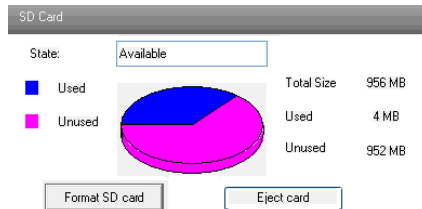

The first time you used the SD card, you should click “Format SD card”.

Click “Eject card” to stop writing data to SD card. Then the SD card can be ejected safely.



Note: Using of SD card function should be coordinated with motion or sensor alarm. When alarm is triggered, the system will automatically snap picture and save the picture into SD card.

5.2 Video Configuration

Camera Configuration includes five submenus: Camera Configuration, Video Stream, OSD Config, Video Mask and ROI Config.

5.2.1 Camera Configuration

Setting steps:

1. Go to “Video Configuration” → “Camera” interface as shown below.

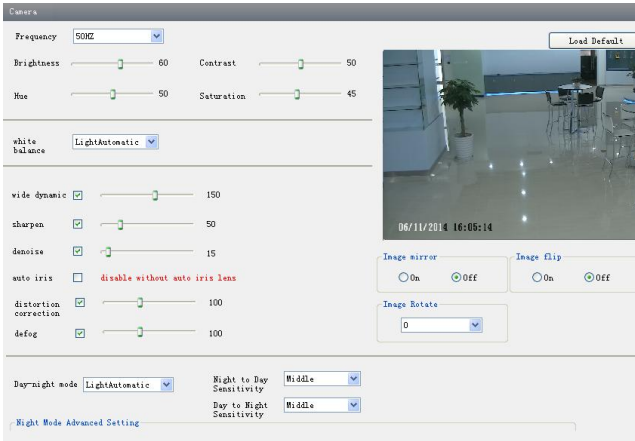

2. You may adjust brightness, contrast, hue and saturation of the picture.
3. Select white balance mode.
4. Wide dynamic, sharpen, and denoise are adjustable.
5. You can also set day-night mode and enable the image mirror and image overturn function.
6. You may frequency and repair bad pixel.
7. Press the “Save” button to save the settings.

5.2.2 Video Stream

Go to “Video configuration” → “Video Stream” to see an interface as shown below.

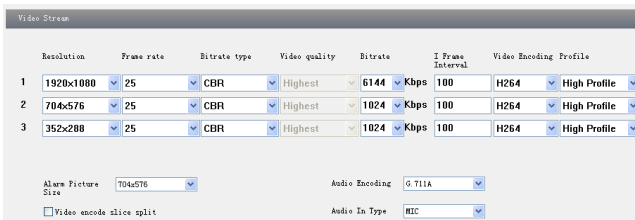

Three video streams can be adjustable.

Resolution: The higher the resolution is, the clearer the image is.

Frame rate: The higher the frame rate is, the more fluently the video is. However, more storage room will be taken up.

Bitrate type: Including CBR and VBR. CBR means that no matter how changeable the video resources are, the compression bitrate keeps constant. This will not only facilitate the image quality better in a constant bitrate but also help to calculate the capacity of the recording. VBR means that the compression bitrate can be adjustable according to the change of the video resources. This will help to optimize the network bandwidth.

Video Quality: When VBR is selected, you need to choose image quality. The higher the image quality you choose, the more bitrate will be required.

Bitrate: Please choose it according to the actual network situation.

I Frame interval: It is recommended to use the default value. If the value is over high, the read speed of the group of pictures will be slow resulting in the quality loss of the video.

Video encoding profile: Baseline and main profile are optional. Baseline profile is mainly used in interactive application with low complexity and delay. Main profile is mainly used for higher coding requirement.

Alarm picture size: Please select it according to the actual situation.

Video encode slice split: If enabled, you may get more fluency image even though using the low-performance PC.

5.2.3 OSD Configuration

Go to “Video Config” → “OSD Config” menu to display the interface as shown below.

You may set time stamp, device name and custom OSD here. Drag the time stamp and custom OSD to set their position. Then press the “Save” button to save the settings.

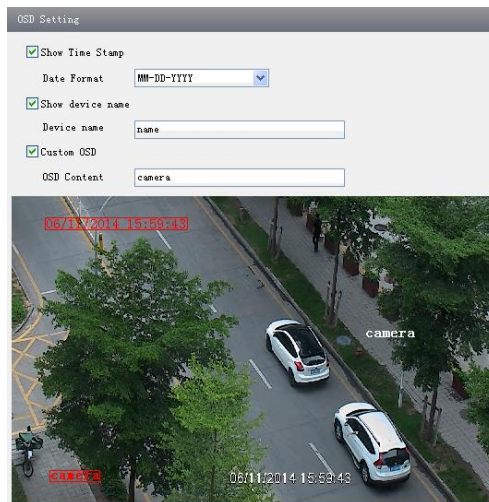

5.2.4 Video Mask

You can set 4 mask areas at most.

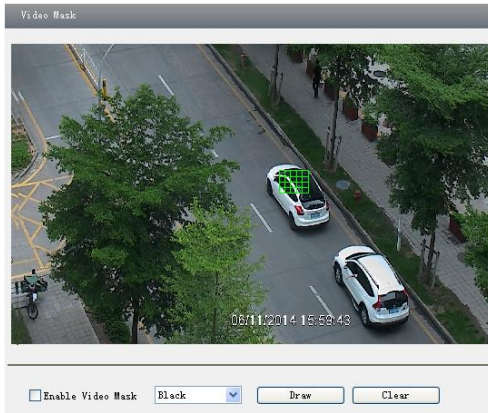

To set up video mask

1. Enable video mask and select mask color.
2. Click “Draw” button and then drag the mouse to draw the video mask area.
3. Click “Save” button to save the settings.
4. Return to the live to see the following picture.



Clear the video mask:

Go to video mask menu and then click “Clear” button to delete the current video mask area.

5.2.5 ROI Configuration

To set up ROI

1. Go to Config→ROI Config menu.

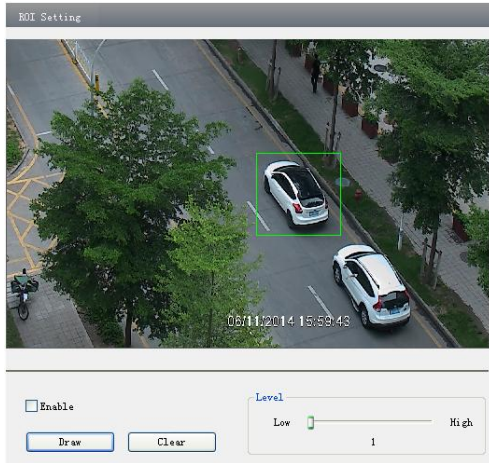

2. Check “Enable” and then click “Draw” button.
3. Drag the mouse to set the ROI area.
4. Set the level.
5. Click “Save” button to save the settings.

Now, you will see the selected ROI area is clearer than other areas especially in low bitrate condition.

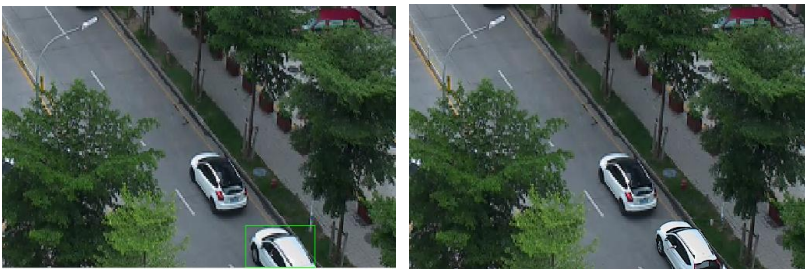

5.3 PTZ Configuration

PTZ Configuration includes two submenus: Protocol and Preset.

5.3.1 Protocol

1. Go to “PTZ Configuration”→ “Protocol” interface as shown below:

Protocol Config

Enable / Disable PTZ Controls

Protocol:

Address:

Baud Rate:

2. Input the protocol, address and baud rate according to the speed dome.

5.3.2 Preset Configuration

1. Go to “PTZ Configuration” → “Preset” to see an interface as shown below:



Button	Meanings
	▲ to rotate the dome upwards; ▼ to rotate the dome downwards; ◀ to rotate the dome towards left; ▶ to rotate the dome towards right; ■ to stop rotating the dome.
	Focus button. Click button to have long focus; click button to have short focus.
	Zoom button. Click button to zoom in the locale picture ; click button to zoom out the locale picture.
	Iris button. Click button to increase light of the dome; click button to decrease the light of the dome.
	Drag the scroll bar to adjust rotating speed of the dome.

2. Input the preset number and set its position by controlling PTZ control panel and then click Add button to add preset point into the Available position list.

3. Select the preset in the pull down list of the Available position and click Go to button to move the dome to this preset point; click Delete button to delete checked preset point.

4. After finishing setting, click Save button to save the settings.

5.4 Alarm Configuration

Alarm configuration includes six submenus: Motion Detection Area, Motion Detection Trigger, Motion Detection Schedule, Alarm Input Trigger, Alarm Input Schedule and Alarm Out.

5.4.1 Motion Detection Area

1. Go to “Alarm configuration”→ “Motion Detection Area” to see an interface as below.

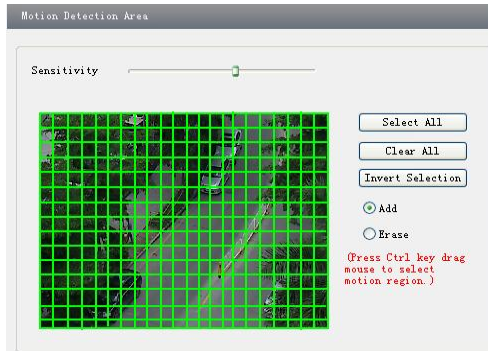

2. Move the “Sensitivity” scroll bar to set up the motion trace sensitivity.
3. Check the “Add”, press the “Ctrl” button and move mouse to select the motion detection area. Select “Erase” and move the mouse to clear all motion detection area.
4. Press the “Save” button to save the settings.

5.4.2 Motion Detection Trigger

1. Go to “Alarm Configuration”→ “Motion Detection Trigger” to display an interface as shown below.

2. Check “Enable alarm” check box. Then motion based alarm is activated.

3. Set alarm holding time.
4. Set alarm trigger options.

Alarm Out: If selected, this would trigger the external relay output on detecting a motion based alarm.

Trigger Snap: If selected, the system will snap images on an alarm and save them in SD card.

Trigger Email: If the email and attach picture checkbox is checked (Email address shall be set first in the Mail config interface), the triggered snap pictures and event will be sent into those address.

Trigger FTP: If “Uploading picture” is checked, the triggered snap pictures will be sent into FTP server address. Please refer to FTP configuration chapter for more details.

5. Press the “Save” button to save the settings.

5.4.3 Motion Detection Schedule

Go to “Alarm configuration”→ “Motion Detection schedule” interface as shown below.

Week schedule

User could set the alarm time from Monday to Sunday for alarm everyday in one week.

“Add”: Add the schedule for a special day.

“Erase”: Delete holiday schedule.

Day schedule

You could set alarm time for alarm in some time of special day, such as holiday.

1. Select a date at the “Date” pull down list, press “Add” button to add that date to the list box on the right side and then move the scroll bar to set the schedule of that day.
2. Select a date in the list box on the right side, and press “Erase” to remove the schedule on that day.

Press the “Save” button to save the settings.

Note: Holiday schedule is prior to Week schedule.

5.4.4 Alarm Input Trigger

1. Enter “Alarm Configuration”→“Alarm Input Trigger” to see a screen as shown below:

2. Select the sensor at the “Sensor” pull down list and set the sensor name and alarm type: NO and NC.

3. Enable alarm and select alarm holding time.

4. Set alarm trigger options. The setting steps are the same with that of motion detection trigger. Please refer to motion detection trigger chapter for details.

5. Apply settings to all by clicking “Copy” button, which can quickly set the same settings for all sensors.

5.4.5 Alarm Input Schedule

Go to “Alarm Configuration”→“Alarm Input Schedule” as shown below:

1. Select the sensor which needs to setup the alarm parameter at the “Sensor” pull down list.
2. The following setup steps are similar to Motion Detection Schedule’s. Please refer to Motion Detection Schedule chapter for more details.

5.4.6 Alarm Out

1. Go to “Alarm configuration”→ “Alarm output” as shown below:

Alarm out setting	
Alarm Out	Alarm out1
Alarm Holding Time	10 Seconds

2. Select alarm holding time and alarm name at the “Alarm out” and “Alarm holding time” pull down list box respectively.
3. Press the “Save” button to save the settings.

5.5 Network Configuration

Network configuration includes eight submenus: Port, Wired, Server Configuration, IP Notify, DDNS Config, RTSP, UPnP, Mail Setting and FTP.

5.5.1 Port

1. Go to “Network config”→ “Port” to see the interface as shown below.

Network basic config	
HTTP Port	80
Data Port	1024
RTSP Port	554

2. Input port number for IE access in the “HTTP Port” textbox.
3. Input the port number for audio & video transmission in the “Data Port” textbox.

5.5.2 Wired

1. Go to “Network Configuration”→ “Wired” to see a tab shown below.
2. There are two options for IP setup: obtain an IP address auto by DHCP protocol and use the following IP address. You may choose one of options as required.
3. Use the following IP address: display the IP address, subnet mask, gateway and DNS of the device.

The screenshot shows two configuration panels. The top panel, titled "IP Config", has two radio button options. The first option, "Obtain an IP address automatically", is selected. The second option, "Use the following IP address", is unselected. Below the second option are input fields for "IP Address" (192.168.15.24), "Subnet Mask" (255.255.255.0), and "Gateway" (192.168.15.1). The bottom panel, titled "PPPoE Config", has a checkbox for "PPPoE" which is unselected. Below it are input fields for "User Name" and "Password".

4. PPPoE: User needs to manual input the user name and password for dial-up internet. Firstly, log in IE clients and then enter user name and password of PPPoE, save the setting and exit. Secondly, set up IP address change notice. Thirdly, connect with Modem. Then the device will dial up internet automatically.
5. Press the “Save” button to save the settings.

5.5.3 Server Configuration

Go to “Network Configuration”→ “Server Config”.

The screenshot shows the "Server Config" web interface. It features a checked checkbox labeled "Do you want IPCamera to connect Server". Below this are three input fields: "Server Address" (empty), "Server Port" (0), and "Device ID" (1).

1. Check “Do you want IP Camera to connect Server”.
2. Check the IP address and port of the transfer media server in the CMS/NVMS. Then enable the auto report in the CMS/NVMS when adding a new device. Next, self-define the device ID and input the remaining information of the device in the CMS/NVMS.
3. Input the above-mentioned server IP, server port and device ID in the relevant boxes.
4. Click “Save” button to save the settings.

5.5.4 IP Notify

1. Go to “Network Configuration”→ “IP Notify” to see a tab as shown below.

2. If the “Enable notifying change of IP” is selected, when the IP address of the device is changed, a new IP address will be sent to the appointed mailbox automatically; If “FTP” is selected, when the IP address of the device was changed, a new IP address will be sent to FTP server.

The screenshot shows a configuration window titled "IP change notification". It contains two checked checkboxes: "Enable notifying change of IP" and "FTP". Below these are two text input fields: "Receival email address" and "Server address".

5.5.5 DDNS Configuration

1. Go to “Network Configuration”→ “DDNS Configuration” tab as shown below.

The screenshot shows a configuration window titled "DDNS config". It features a checked checkbox for "Enable DDNS". Below this is a dropdown menu for "DDNS Server Type" set to "www.dyndns.com". There are also text input fields for "User Name", "Password", and "Domain".

2. Apply for a domain name. Take www.dvrdydns.com for example.

Input www.dvrdydns.com in the IE address bar to visit its website. Then click “Registration” button to register as shown below.

The screenshot shows a "NEW USER REGISTRATION" form with the following fields:

- USER NAME: xxxxx
- PASSWORD: masked with dots and a strength indicator
- PASSWORD CONFIRM: masked with dots
- FIRST NAME: xxx
- LAST NAME: xxx
- SECURITY QUESTION: My first phone number.
- ANSWER: xxxxxxx
- CONFIRM YOU'RE HUMAN: Includes a CAPTCHA image showing the number 78408 and a text input field for verification.

 At the bottom are "Submit" and "Reset" buttons.

Create domain name.

You must create a domain name to continue.

Domain name must start with (a-z, 0-9). Cannot end or start, but may contain a hyphen and is not case-sensitive.

,

After you successfully request your domain name, you will see your domain in the list.

Search by Domain:

Click a name to edit your domain settings.

NAME	STATUS	DOMAIN
654321ABC	✔	654321abc.dvrddns.com

Last Update: *Not yet updated* IP Address: 210.21.229.138

[Create additional domain names](#)

3. Select the server type and then input the username, password and domain name you apply for in the DDNS configuration interface.
4. Click “Save” button to save the settings.

5.5.6 RTSP

Go to “Network Configuration” → “RTSP” interface as shown below.

RTSP

Enable RTSP server

RTSP Port:

RTSP Address:

Enable anonymous viewer login (no user name or password required)

1. Select “Enable RTSP server”.
2. RTSP Port: Access Port of the streaming media. The default number is 554.
3. RTSP Address: The RTSP address you need to input in the media player.
4. You can also choose to enable anonymous viewer login.

5.5.7 UPnP

Go to “Network Configuration” → “UPnP” interface as shown below.
Select “Enable UPnP” and then input friendly name.

UPnP Setting

Enable UPnP

Friendly Name:

Then double click “Network” icon on the desktop of the PC to see an icon with the friendly name and IP address of the camera. You may quickly access the device by double clicking this icon.

5.5.8 Mail Setting

Go to “Network Configuration” → “Mail Setting” interface.

The screenshot shows the 'Mail config' interface. It contains the following fields and controls:

- From Email:** test10007@gmail.com
- User Name:** test10007@gmail.com
- Password:** [masked]
- Server address:** smtp.gmail.com
- SMTP Port:** 465
- Secure Connection:** not required (dropdown menu)
- Buttons:** Use default, test your account settings
- Receival email address list:** A table with one empty row and 'Add' and 'Delete' buttons below it.

1. From Email: Sender’s e-mail address.
2. User name and password: Sender’s user name and password.
3. Server address: SMTP name of sender.
4. Select the secure connection type at the Secure Connection pull down list according to user’s actual needs.
5. Receival email address list: Add email address into the list.
6. Receival email address: Receiver’s e-mail address.
7. After all parameters set up, you can click “Test your account settings”. If email sent successful, a “Test Successful” window will pop up, if not, users can try other email addresses or check the setting.

Notice: If you change the static IP into PPPoE and select mailbox, there will be an e-mail sent to your mail box for notifying a new IP address.

5.5.9 FTP

Go to Network Configuration → FTP interface as shown below.

The screenshot shows the 'FTP Setting' interface. It contains the following elements:

- Table:**

Server name	Server address	Port...	User Name	Upload path:
- Buttons:** Add, Modify, Delete, Test

1. Add: Click Add button to input FTP server’s server name, address, port number, user name,

password, and upload path, click OK to confirm the setting.

2. Modify: Click this button to change some information of the FTP server.
3. Delete: Select a certain FTP account and click this button to delete this account.
4. Test: Select a certain FTP account and click this button to test its valid or not.

Please refer to the following table for parameters and instructions of FTP configuration.

<i>Parameter</i>	<i>Meaning</i>
Server name	The name of the FTP server
Server address	The address of the FTP server
Port	The port number of the FTP server
User name	The user name of the FTP server
Password	The password of the FTP server
Path	The save path for FTP files

5.6 Advanced Configuration

Advanced configuration includes four submenus: User Configuration, Security Configuration, Configure Backup & Restore, Reboot and Upgrade.

5.6.1 User Configuration

Go to “User Configuration” interface.

Add user:

1. Clicking “Add” button pops up “Add user” dialog box.

User Configuration

Add User

Note: After binding physical address to the IP-CAM, you can access the device on this PC in network only. If the MAC address was “00:00:00:00:00:00” which means it can be connected to any computers.

2. Input user name in “User Name” textbox (only letters).
3. Input characters in “Password” and “Confirm Password” textbox (letters or numbers).
4. Input the MAC address of the PC in “Binding MAC address” textbox.
5. Click “OK” button and then the new added user will display in the user list.

Modify user:

1. Select the user which needs to modify password and physical address in the user configuration list box.
2. Clicking “Modify” button will pop up “Modify user” dialog box as shown below.

Modify User

3. Input original password of this user in the “Password” text box.
4. Input new password in the “New password” and “Confirmation” text box.
5. Input computer’s physical address which is used to access the server in the “User PC MAC” text box.
6. Click “OK” button to modify password and binding MAC address successfully.

Delete user:

1. Select the user which needs to delete in the user configuration list box.
2. Clicking “Delete” button will pop up a confirm dialog box. Then click “OK” to delete the user.

Note: The default super administrator cannot be deleted.

<i>Parameter</i>	<i>Meaning</i>
User Name	User name to operate the logon client end
User Type	Type of users, normal user, advanced user and super administrator
Binding MAC address	The MAC addresses of user access the server which should set up according to actual MAC address of server.
Password	Password to log in the client terminal
Confirm Password	Password to log in the client terminal

5.6.2 Security Configuration

1. Go to Advanced Configuration→Security Configuration to see a tab shown below.
2. Check “Enable IP address” check box, select “Deny the following IP address”, input IP address in the IP address list box and click “Add” button. Then this IP address will display in the list box; the operation step of “Allow the following IP address” is the same with “Deny the following IP address”.
3. Select the IP address which needs to be deleted from the IP address list box and click

“Delete” button to delete that IP address.

4. Check “Enable MAC address” check box, select “Deny the following IP address”, input MAC address in the MAC address list box and click “Add” button. Then this MAC address will display in the list box; the operation step of “Allow the following MAC address” is the same with “Deny the following IP address”.

The image shows two configuration panels. The top panel, titled "IP address filter setting", has a checked "Enable IP address filtering" checkbox. Below it are two radio buttons: "Deny the following IP address" (selected) and "Allow the following IP address". There is a large empty list box on the left, and "Add" and "Delete" buttons on the right. The bottom panel, titled "MAC filter setting", has a checked "Enable MAC address filtering" checkbox. Below it are two radio buttons: "Deny the following MAC address" (selected) and "Allow the following MAC address". There is a large empty list box on the left, and "Add" and "Delete" buttons on the right. At the bottom right of the MAC filter setting panel, there is a text input field containing "00 : 00 : 00 : 00 : 00 : 00".

5. Select the MAC address which needs to be deleted from the MAC address list box and click “Delete” button to delete that MAC address.

6. Click “Save” button to save the above setting.

5.6.3 Configure Backup & Restore

Go to Advanced configuration → Configure Backup & Restore Interface.

● **Import & Export Configuration:**

You can import or export the setting information from PC or to device.

1. Click “Browse” to select save path for import or export information on PC.

2. You can import or export all setting information to PC, but those two settings “User Configuration” and “Network Configuration” are exceptional.

The image shows a configuration interface with three sections. The top section, "Import setting", has a "Path" input field with a "Browse" button to its right. Below the path field is a dropdown menu labeled "All configuration exception for" with a checked "User Config" checkbox and an unchecked "Network Config" checkbox. There is an "Import setting" button below. The middle section, "Export setting", has an "Export setting" button. The bottom section, "Default setting", has a "Load Default" button.

● **Default Configuration**

Click “Load default” button to restore all system settings to the default status.

5.6.4 Reboot Device

Go to Advanced configuration—Reboot device to see an interface as shown below. Click “Reboot device” button to reboot the device.

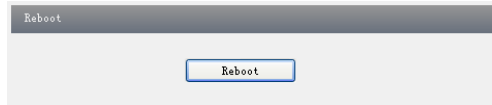

5.6.5 Upgrade

Go to Advanced Configuration—Upgrade interface as shown below.



1. Click “Browse” button to select the save path of the upgrade file.
2. Click “Upgrade server firmware” button to start upgrading the application program.
3. The device will restart automatically.
4. After you successfully update the software, click “OK” button to close IE and then re-open IE to connect IP-CAM.

Notice: You can't disconnect to PC or close the IP-CAM during upgrade.





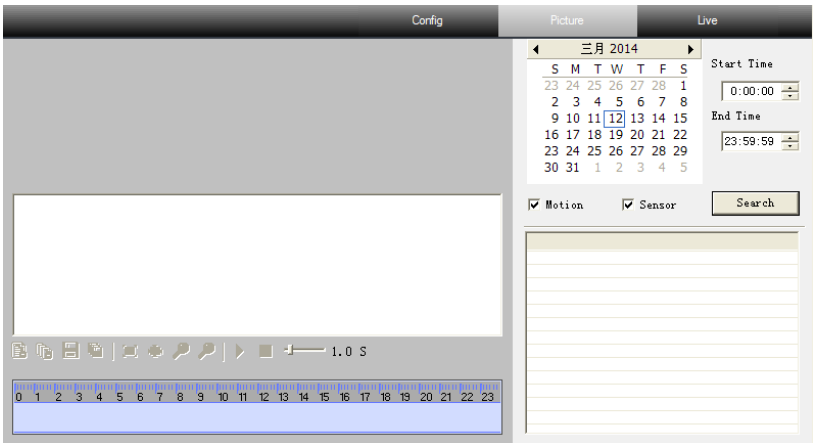



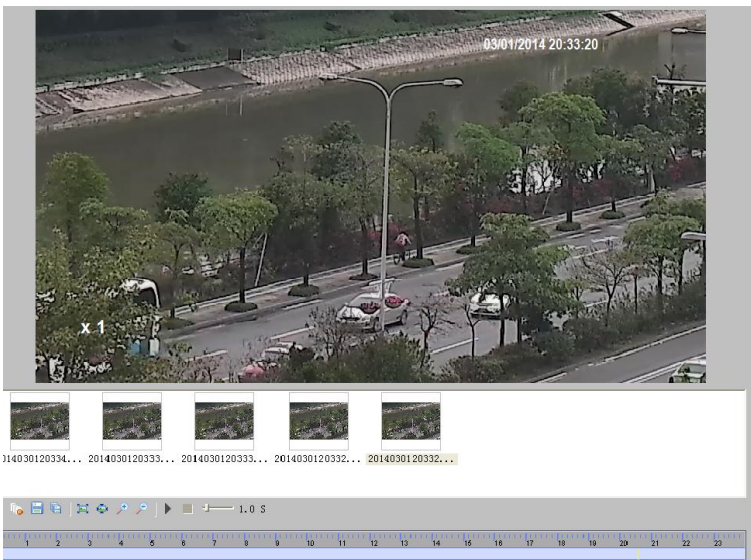

6 Video Search

Click “Picture” icon and search the images which saved in the SD card.



1. Set time: Select date in the “Calendar” and choose the start and end time.
2. Choose event “Motion” or “Sensor”.
3. Click “Search” button to search the picture.
4. Double click a filename or select a filename and then click “View” button in the list box to view captured pictures.



<i>Item</i>	<i>Buttons</i>	<i>Explanations</i>
1		Close: Select certain picture and click this button to close this picture.
2		Close all: Click this button to close all pictures viewing.
3		Save: Click this button to select the save path of the picture file on the PC for saving the current picture.
4		Save all: Click this button to select the save path of the picture files on PC for saving all pictures.
5		Fit size: The picture will fit on screen by clicking this button.
6		Actual size: Click this button to display the actual size of the picture as required.
7		Zoom in: Click this button to amplify the picture.
8		Zoom out: Click this button to zoom out the picture.
9		Slide play: Click this button to play the picture in slide show mode.
10		Stop: Click this button to stop slide show.
11		Play speed: Play speed of the slide show.

7 Q & A

Q: How to find my password if I forget it?

A: Reset the device to the default factory settings.

User name: admin

Password: 123456

Q: Fail to connect devices through IE browser, why?

A: Network doesn't connect well. Please check the connection and make sure it connected well.

B: IP is not available. Reset the valid IP.

C: Web port number has been revised: contact administrator to get the correct port number.

D: Exclude the above reasons. Recover default setting by IP-Tool.

Q: IP tool cannot search devices, why?

A: It may be caused by the anti-virus software in your computer. Please exit it and try to search device again.

Q: IE cannot download ActiveX control. How can I do?

a. IE browser blocks ActiveX. Please do setup following below.

① Open IE browser. Click Tools----Internet Options....

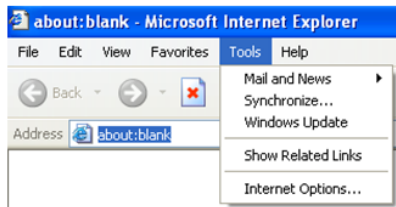

② Select Security-----Custom Level....

③ Enable all the sub options under "ActiveX controls and plug-ins".

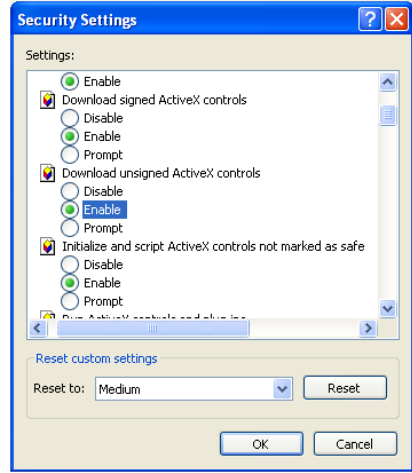
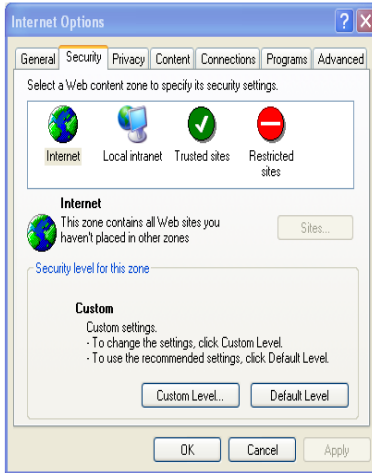

④ Then click OK to finish setup.

b. Other plug-ins or anti-virus blocks ActiveX. Please uninstall or close them.

Q: No sound can be heard, why?

A: Audio input device is not connected. Please connect and try again.

B: Audio function is not enabled at the corresponding channel. Please check AUDIO item to enable this function.

Q: Why doesn't the device connect to wireless?

A: Check the statues of wireless router. Please make sure the router is open.

B: Check the router and the device port.

8 Specification

Model	2 Megapixel IR Water-proof Network Camera	
Camera	Image Sensor	1/2.8 " CMOS
	Image Size	1920 × 1080
	Electronic Shutter	1/25s~1/100000s
	Auto Iris	Fixed Iris
	Min. Illumination	0 Lux (IR ON)
	Lens	7~22mm (6mm, 8mm, 12mm optional)
	Day-Night Switch	ICR auto switch
	WDR	Digital WDR
	DNR	3D noise reduction
Image	Video Compression	H.264/MJPEG
	H.264 Compression	Baseline Profile/Main Profile/High Profile
	Bitrate	64Kbps~8Mbps
	Resolution	1080P(1920 × 1080), 720P(1280 × 720), VGA (640 × 480), QVGA(320 × 240)
	Multi-streams	1920 × 1080(1~30fps)/1280 × 720(1~30fps) 1280 × 720(1~10fps)/640 × 480(1~30fps)/ 320 × 240(1~30fps)
	Image Settings	Saturation, Brightness, Chroma, Contrast, Wide Dynamic, Sharpen, NR., etc., adjustable through client software or web browser
	ROI	Support
Interfaces	Network	RJ45
	Video	CVBS × 1
	Audio	MIC IN × 1, MIC OUT × 1
	Storage	Support SD, up to 64GB
	RS485	Support
	Alarm Input	1 CH
	Alarm Output	1 CH
Function	Remote Monitoring	IE browsing, CMS remote control
	Online Connection	Support simultaneous monitoring for up to 4 users; Support multi-stream real time transmission
	Network Protocol	TCP/IP, UDP, DHCP, NTP, RTSP, PPPoE, DDNS, SMTP, FTP
	Interface Protocol	ONVIF, GB-T/28181-2011
	Smart Alarm	Motion Alarm, Sensor Alarm
	PoE Power Supply	Support
	IR Distance	50-70m
	Water-proof	IP66
Others	Power Supply	DC12V/PoE
	Power Consumption	< 3W (ICR OFF); < 7W (ICR ON)
	Working Environment	-20℃~50℃, 10%~90% humidity
	Dimension	Φ 109mm×360mm
	Weight (Net)	1685g